

Scenic Cruiser

BY GULF STREAM®

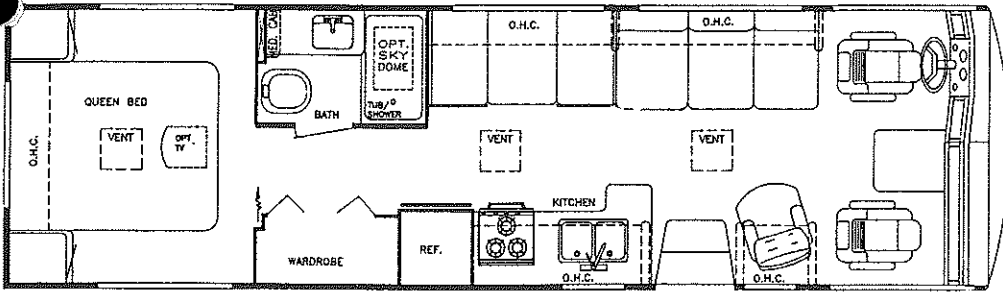

Model 8317 GAS

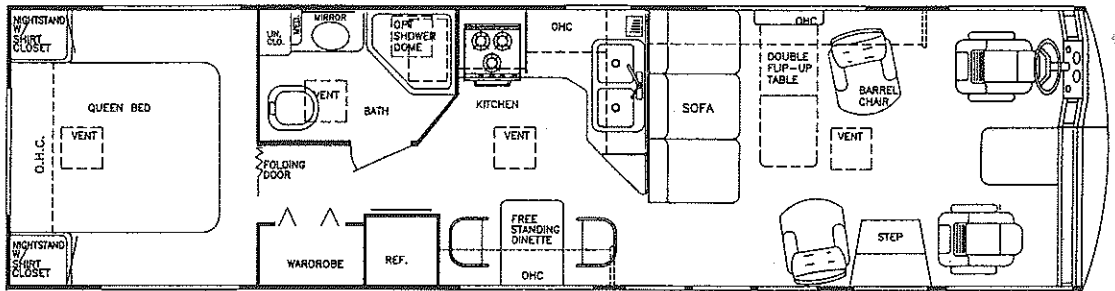

Model 8340 GAS

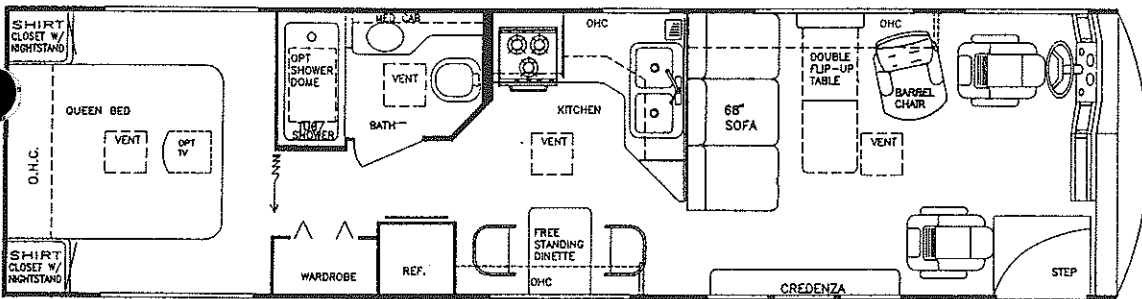

Model 8340 DIESEL

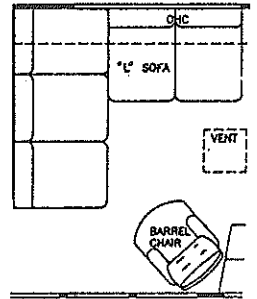

OPT. "L" SOFA

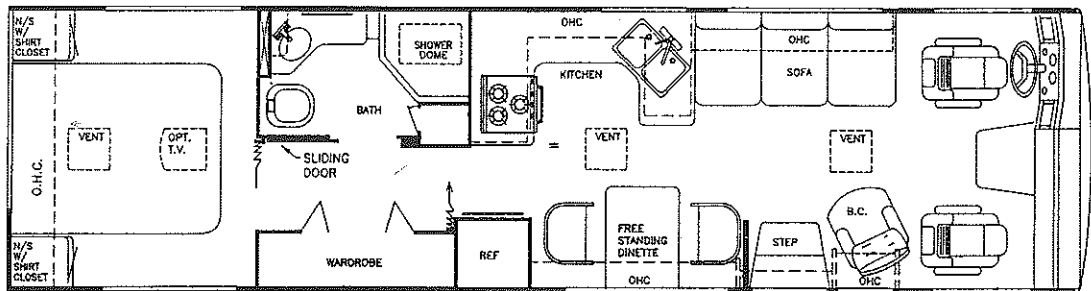

Model 8349 GAS

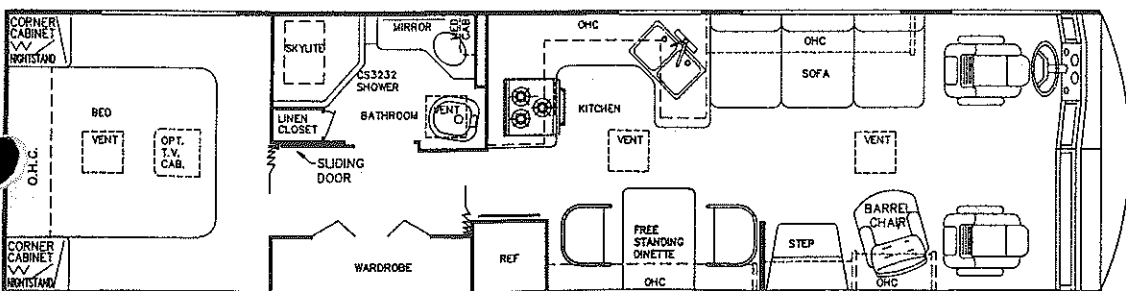

Model 8349 DIESEL

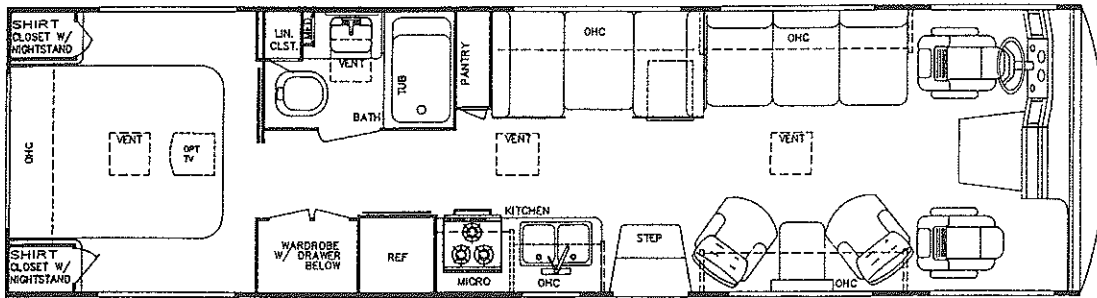

Model 8344 GAS (SOFA AVAILABLE - P/O CHAIRS)

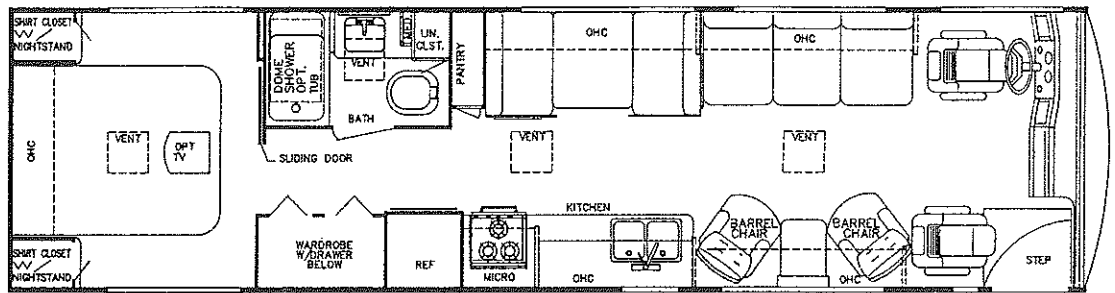

Model 8344 DIESEL (SOFA AVAILABLE - P/O CHAIRS)

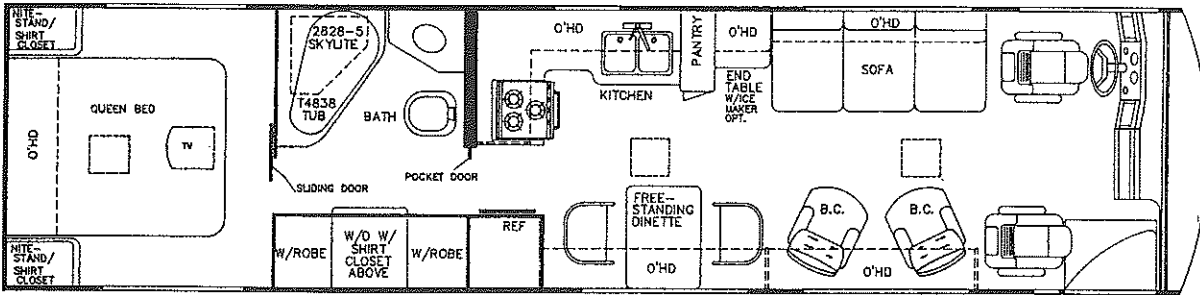

Model 8360 DIESEL

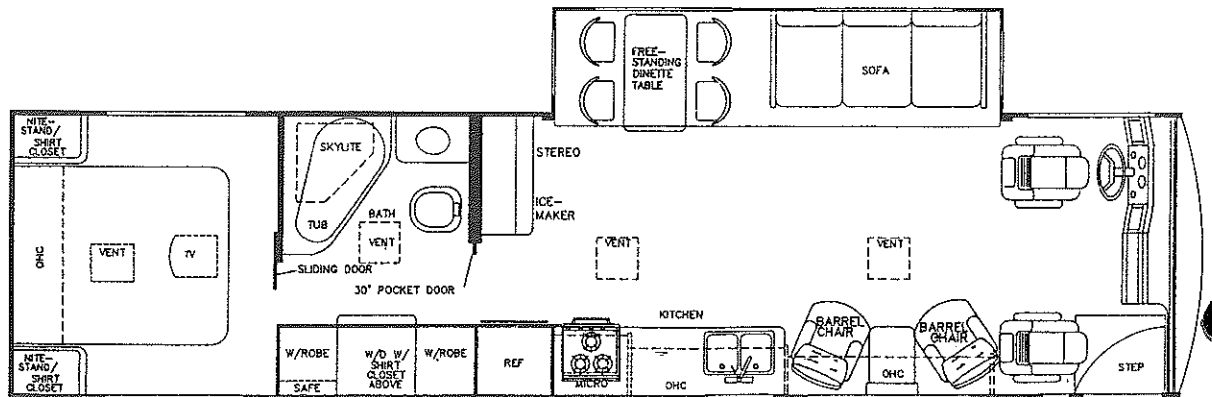

Model 8361 DIESEL

Scenic Cruiser

BY GULF STREAM®

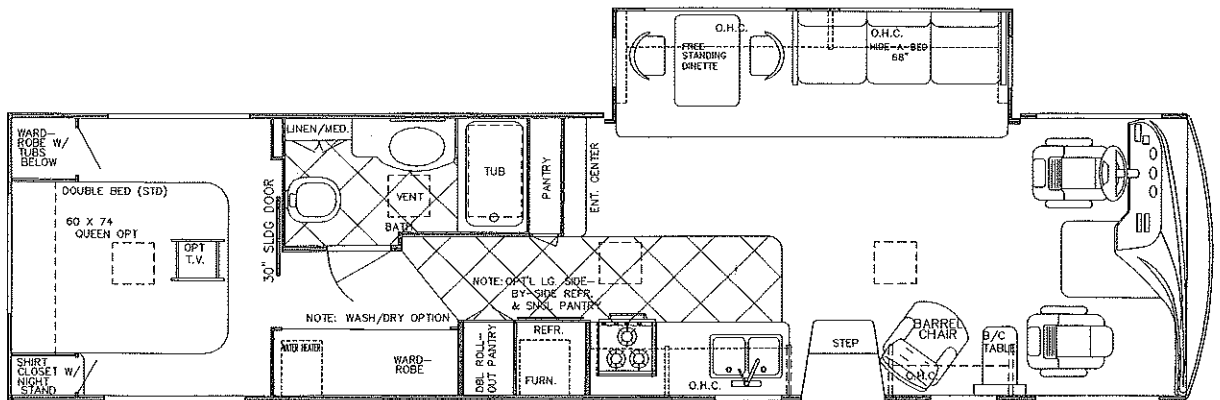

Model 8362 GAS

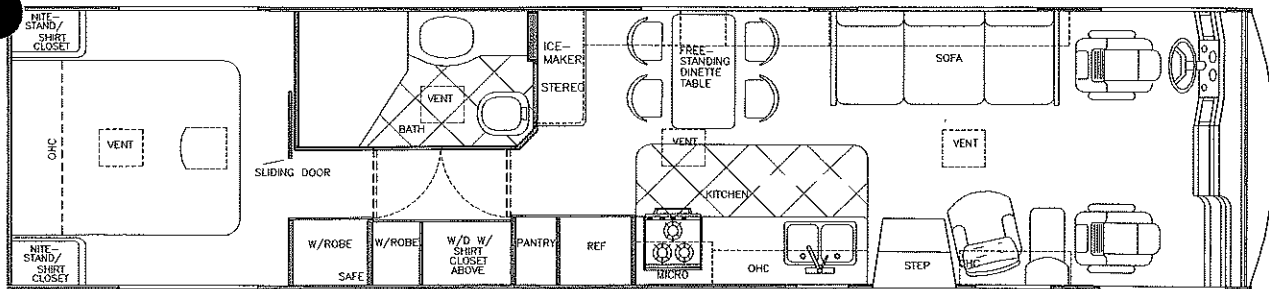

Model 8380 DIESEL

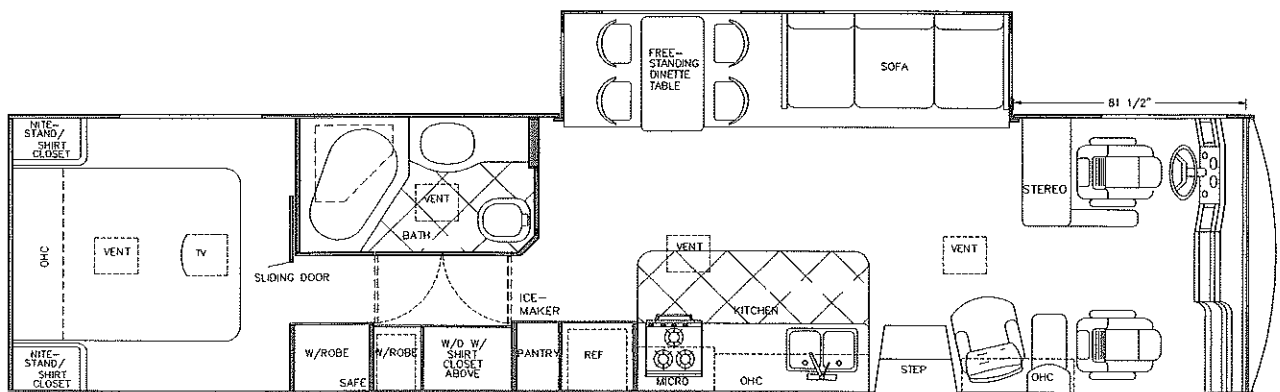

Model 8381 DIESEL

Scenic Cruiser

BY GULF STREAM®

GAS MODELS	8317	8340	8344	8349	8362
FORD Chassis 460 CID V-8:					
Wheelbase	190"	208"	208"	208"	208" + Tag
GVWR (lbs.)	17,000	17,000	17,000	17,000	19,500
Front Gross Axle Wt. Rating	6,000	6,000	6,000	6,000	6,000
Rear Gross Axle Wt. Rating	11,000	11,000	11,000	11,000	13,500 (tag)
DIMENSIONS:					
Overall Length	32' 2"	33' 8"	33' 8"	33' 8"	36' 8"
Overall Height w/Roof A/C	11' 10"	11' 10"	11' 10"	11' 10"	11' 10"
Overall Width	101"	101"	101"	101"	101"
Interior Height	80"	80"	80"	80"	80"
Interior Width	97"	97"	97"	97"	97"
CAPACITIES:					
Fresh Water Tank (Gal.)	48	48	48	48	48
Grey Holding Tank (Gal.)	45	45	45	45	45
Black Holding Tank (Gal.)	45	45	45	45	45
Water Heater w/DSI (Gal.)	6	6	6	6	6
LP Gas Tank (lbs.)	85	85	85	115	115
Fuel Tank (Gal.)	75	75	75	75	75
Furnace (BTU's)	40K	35K	35K	40K	40K

Interior and Decor

- Mirage Ivory or Oak Cabinetry w/Etched Glass Doors in Living Room & Bath
- Solid Surface Kitchen Countertop w/Backsplash and Knife Holder
- Custom Padded Dash w/Illuminated Gauges
- Day/Night Pleated Shades in LVRM & BDRM
- Pleated Privacy Curtain
- 3-Way, Feather Touch Captains Chairs
- Deluxe Furniture Package
- Deluxe Door and Window Drapes
- Coordinated Bedspread and Shams
- Generous Overhead Storage Compartments
- Free Standing Dinette and 2 Chairs (most models)
- Queen Size Bed w/Deluxe Innerspring Mattress
- Mini-Blinds in Kitchen
- Mirrored Closet Doors
- Heavy Duty Clear Vinyl Runner Over Carpet

Electrical Systems

- Easy-Access Dual Battery System
- Power Vent in Bath and Kitchen
- Electric Supply Cord
- Electric Overload Protection
- Automotive-Type, Color-Coded Wiring
- Lighted Entry & Aisle Lights

Exterior and Construction

- Unified "New Generation" Body Structure
 - 1-1/2" x 1-1/2" Tubular Steel Sub-Floor Trusses
 - 1-1/2" x 1-1/2" Tubular Steel Floor Framing
 - Vacuum-Bond Laminated Floor w/Metal Under-Belly
 - Vacuum Bond Laminated Sidewalls w/Tubular Metal Framing and One Piece Fiberglass w/Mende Backer
 - Vacuum Bond Laminated Roof w/Metal Framing, Bowed Roof Trusses and Block Foam Insulation
- One-Piece, Radiused Rubber Roof w/12 Year Warranty
- Virtually Seamless Weyerhaeuser Structurwood Floor Decking w/10 Year Warranty
- Angled Steel Sidewall-to-Roof Transition Member
- Hinged Exterior Storage Doors
- Heated & Fully Enclosed Holding Tanks
- High-Density Block Foam Insulation Throughout
- Molded Roof Brick Insulation, Surrounds Ducted Roof A/C
- Sidewalls Lag-bolted Every 8" to Floor Structure
- Fully Welded Steel Firewall
- Rear Fiberglass Cap with Integrated Bumper
- Outstanding Side-to-Side, Carpeted and Lighted Exterior Storage
- Radius Entry Door w/Deadbolt Lock
- Sealed Perimeter and Engine Compartment
- Large Panoramic Windshield
- Deluxe Outside Mirrors
- Jalousie Windows in Bedroom

Bath and Water

- Super-Flow Manifold Water Distribution System
- Demand Water System
- City Water Hook-Up
- Double Stainless Steel Sink (Kitchen)
- White Single Lever Kitchen Faucet
- Sink Covers
- Gold Neo-Angle Shower Surround
- Sky Dome in Shower Area
- Brass Look Bath Fixtures
- Mirrored Medicine Cabinet
- Dual Pedestal Marine Toilet w/Sprayer
- One-Piece Fiberglass Tub

Appliances

- Deluxe 3-Burner High-Performance Range w/Oven
- Lighted Power Range Hood
- 19" Color TV (VCR Ready)
- TV Antenna w/Amp, Boost and 2 Jacks
- 2-Door, 2-Way Refrigerator
- LP Gas Leak Detector
- Carbon Monoxide Detector

Heating and Air Conditioning

- Ducted Furnace w/Elect. Ignition 40,000 BTU (most models)
- Pre-Wired for Ducted Roof A/C

SPECIFICATIONS

DIESEL MODELS	8340	8344	8349	8360	8361	8380	8381
ALPINE Chassis:							
Engine (HP)	250/275	250/275	250/275	250/275	250/275	N/A	N/A
Wheelbase	208"	208"	208"	234"	234"	N/A	N/A
GVWR (lbs.)	24,000	24,000	24,000	24,000	24,000	N/A	N/A
Front Gross Axle Wt. Rating	9,000	9,000	9,000	9,000	9,000	N/A	N/A
Rear Gross Axle Wt. Rating	15,000	15,000	15,000	15,000	15,000	N/A	N/A
FREIGHTLINER Chassis:							
Engine (HP)	N/A	N/A	N/A	N/A	N/A	300	300
Wheelbase	N/A	N/A	N/A	N/A	N/A	252"	252"
GVWR (lbs.)	N/A	N/A	N/A	N/A	N/A	26,000	26,000
Front Gross Axle Wt. Rating	N/A	N/A	N/A	N/A	N/A	10,000	10,000
Rear Gross Axle Wt. Rating	N/A	N/A	N/A	N/A	N/A	16,000	16,000
DIMENSIONS:							
Overall Length	33' 8"	33' 8"	33' 8"	37' 6"	37' 6"	39' 0"	39' 0"
Overall Height w/Roof A/C	12' 0"	12' 0"	12' 0"	12' 0"	12' 0"	12' 1"	12' 1"
Overall Width	101"	101"	101"	101"	101"	101"	101"
Interior Height	80"	80"	80"	80"	80"	80"	80"
Interior Width	97"	97"	97"	97"	97"	97"	97"
CAPACITIES:							
Fresh Water Tank (Gal.)	55	55	55	55	55	55	55
Grey Holding Tank (Gal.)	45	45	45	45	45	45	45
Black Holding Tank (Gal.)	45	45	45	45	45	45	45
Water Heater w/DSI (Gal.)	6	6	6	10	10	10	10
LP Gas Tank (lbs.)	115	115	115	115	115	150	150
Fuel Tank (Gal.)	100	100	100	100	100	100	100
Furnace (BTU's)	40K	35K	40K	42K	42K	42K	42K

Chassis (Gas Models)

- Super Duty FORD w/460 CID V-8 and 4-Speed Automatic Transmission
- Power Steering w/Front and Rear Disc Brakes

Chassis (Diesel Models)

- Spartan ALPINE Chassis, w/Cummins 6CTA 8.3, 250HP, 660 ft.lb. Torque Turbo-Charged Rear Mounted Diesel Engine
- Allison MD-3060P 6-Speed, Electronically Shifted Automatic Transmission
- Full Air-Ride Suspension
- Full Air Brakes
- High Capacity Automotive Heater
- Tilt Steering Wheel
- *38' Models ONLY: Freightliner Chassis Featuring a Cummins 8.3 Litre, Turbo-Charged 300 HP Rear Mounted Diesel Engine*

Deluxe Standard Features

- Auto Dash Air Conditioner
- Auto Cruise Control
- Stainless Steel Wheel Inserts
- Rally Hook-Up
- Electric Step
- Rear Ladder
- Floor Mats
- Super Slick Exterior Fiberglass
- AM/FM Cassette w/4 Spkrs.
- Monitor Panel in Range Hood
- 115 lb. LP Tank (85 lb. on gas models)
- Radial Tires
- Tinted Windshield & Windows
- Wall Safe
- Lighted Entry Step
- Driving Lights

Your Dealer:



GULF STREAM COACH, INC.

P.O. Box 1005 • Nappanee, IN 46550

For further information and available floorplan options, contact your local dealer or Gulf Stream Coach, Inc. Gulf Stream Coach, Inc. reserves the right to make changes in prices, colors, materials, components and specifications and to discontinue models at any time without notice or obligation. Gulf Stream Coach, Inc. assumes no responsibility for any error in type or print reproduction of specifications or floorplans in this brochure.

TP-20M-9/96 © 1996 Gulf Stream Coach, Inc. - Nappanee, Indiana

IF YOU WANT A COACH THAT'S BUILT AS WELL AS A GULF STREAM...

1. Seamless Rubber Roof For Greater Energy Efficiency and Dependability.
2. Luan Decking for Additional Strength.
3. Molded E.P.S. Brick Insulation Provides Consistent Insulative Value As Well As Superior Dimensional Rigidity.
4. One-Piece Formed Aluminum Air Conditioning Duct, Completely Surrounded By Polystyrene Insulation.
5. Bubble-Wrapped Foil Insulation Provides Superior Insulation.
6. Rugged Welded Tube Roof Framing.
7. Soft Touch Ceiling Fabric for Added Sound Insulation.
8. Aluminum Cove Molding.
9. Bubble-Wrapped Foil Insulation Minimizes Thermal Transfer.
10. Rugged Roll-Formed Steel Roof-to-Sidewall Transition Member Insures Structural Integrity and Stability.
11. Die-Stamped Steel Transition Member Gusseting Provides Greater Strength and Structural Integrity.
12. Rugged Heavy-Gauge Tubing, Fixture Welded to Form the Sidewall Framing.
13. High-Density E.P.S. Insulation Provides Superior Laminating and Bonding Characteristics and Insures Greater Energy Efficiency.
14. Interior Wall Panels Securely Laminated to Steel Framed Sidewall.

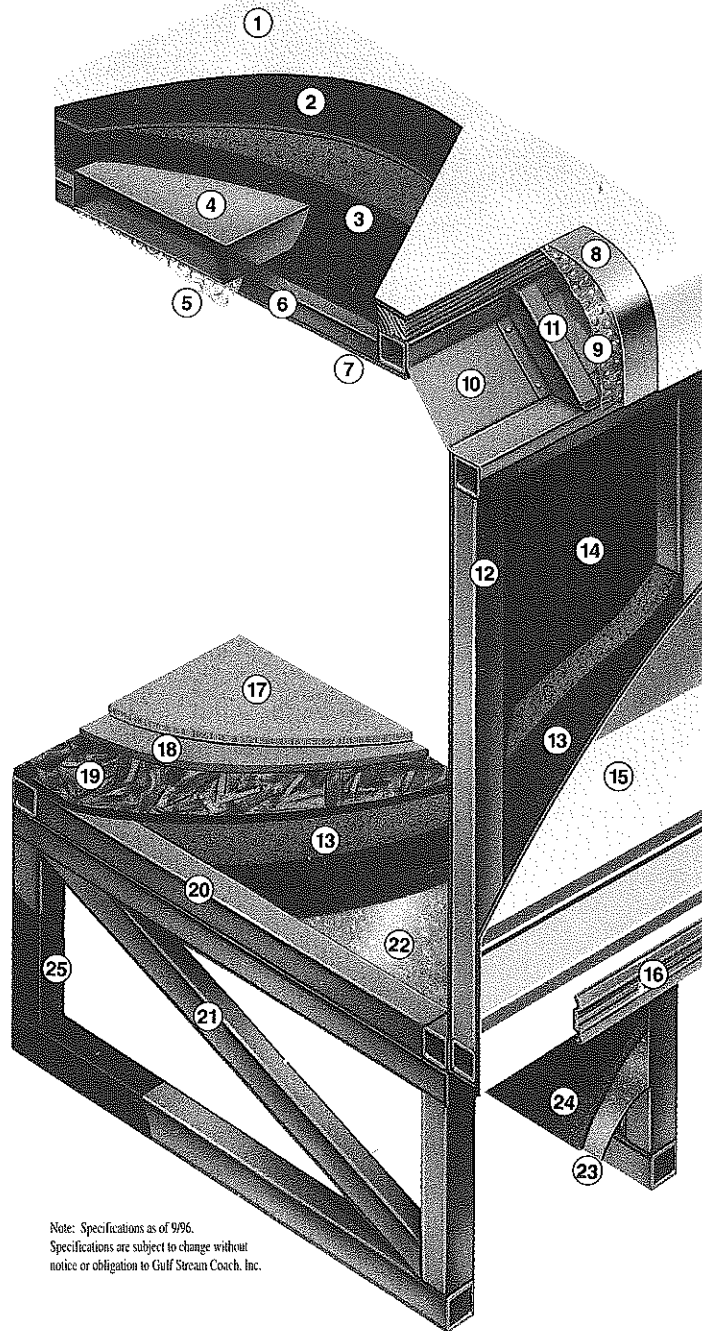

Note: Specifications as of 9/96.
Specifications are subject to change without
notice or obligation to Gulf Stream Coach, Inc.

15. "Fiberspan" Fiberglass Exterior Body Surface Vacuum Laminated to Steel Side-wall Framing for Lasting Beauty and Durability.
16. Aluminum Trunk Door Hinge Extrusion Provides A Tight Seal Discouraging Air or Water Infiltration.
17. High-Quality Stain-Resistant Carpeting Available in Designer- Coordinated Colors.
18. Extra-Thick Padding Under Carpet Provides Extra Comfort and Increases Carpet Durability.
19. Continuous Structurewood Floor Decking Laminated to Steel Floor Structure Assures a Quiet, Long-Lasting, Rigid Floor
20. Heavy-Gauge Steel Tube Framing, Fixture Welded for Extra Strength and Stability.
21. Heavy-Gauge Steel Tube Framing, Fixture Welded Floor Truss System Provides the Strongest Motorhome Foundation in the Industry.
22. Seamless Layer of Galvanized Steel Securely Laminated to the Steel Floor Framing.
23. Galvanized Steel Used to Form Each Storage & Holding Compartment.
24. Durable All-Weather Carpeting Completes Each Accessible Storage Compartment, Providing Extra Protection for Luggage and Valuables.
25. Rust-Prohibitive Paint Coating Applied to All Steel Framing Assures Corrosion and Rust Protection.



IT'S GOING TO HAVE TO BE A GULF STREAM!